

EXERCISES. In which direction must the object be viewed to produce the views shown opposite, taking 'A' as the FRONT VIEW. Put the appropriate letter under the view.

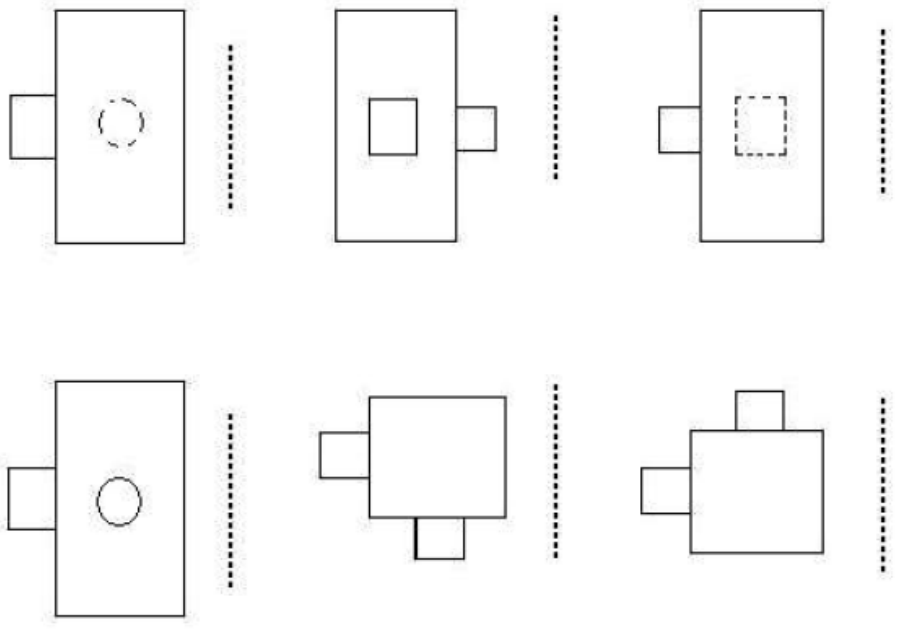
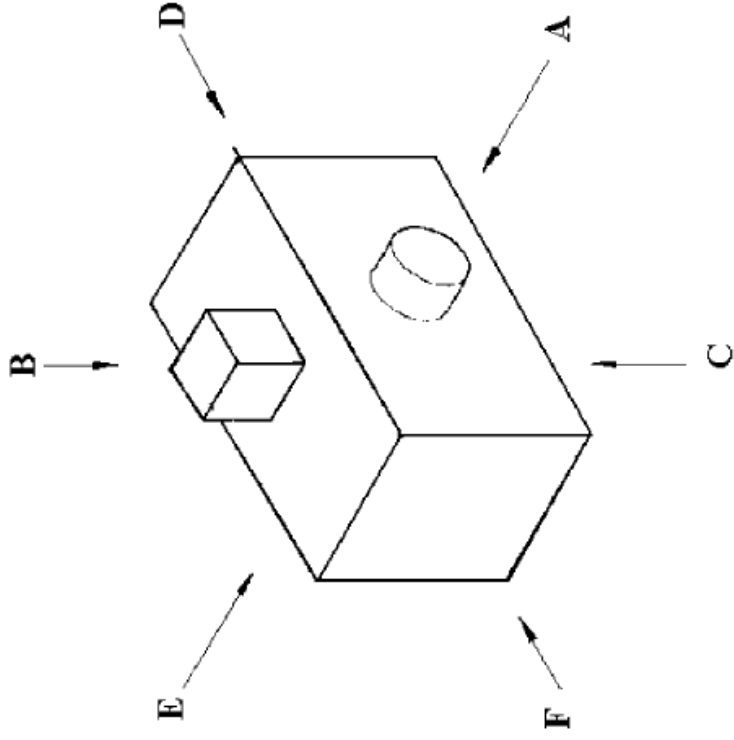

DRG.

ORTHOGRAPHIC PROJECTION

EXERCISE 1

EXERCISES. Study the two drawings and complete the table by matching the numbered surfaces of the orthogonal drawing with the lettered surfaces of the isometric drawing.

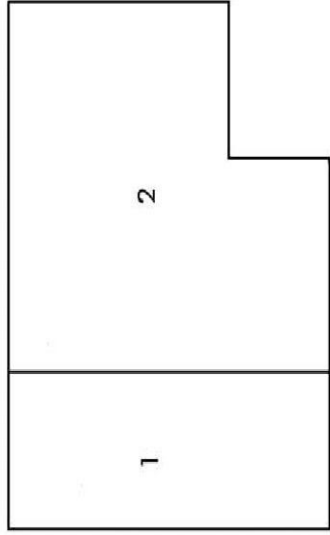
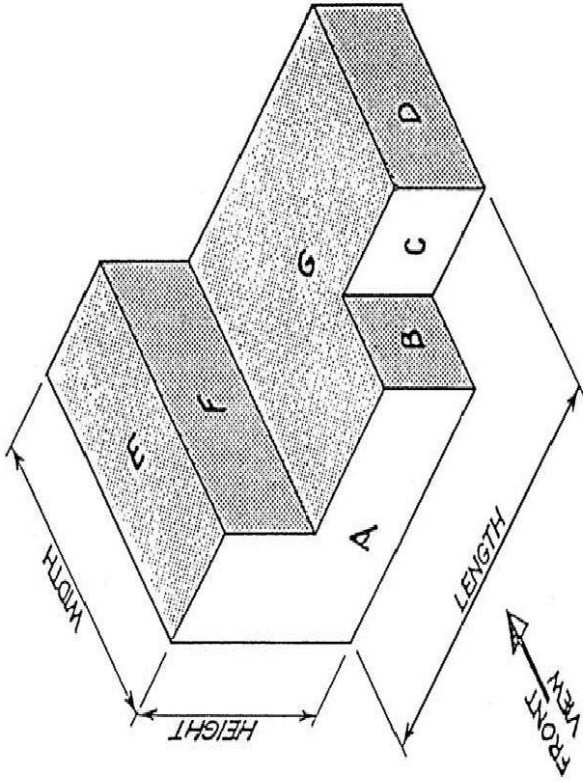

TOP VIEW

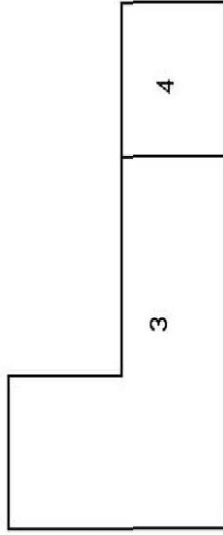

FRONT VIEW

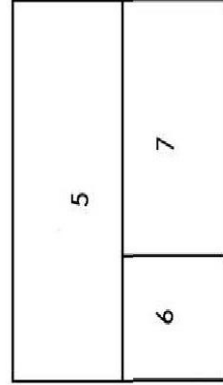

SIDE VIEW

A	B	C	D	E	F	G

DRG.

ORTHOGRAPHIC PROJECTION

EXERCISE 2

EXERCISES. Transfer the letters from the isometric drawing onto the same plane surfaces of the orthogonal drawing. Name each view.

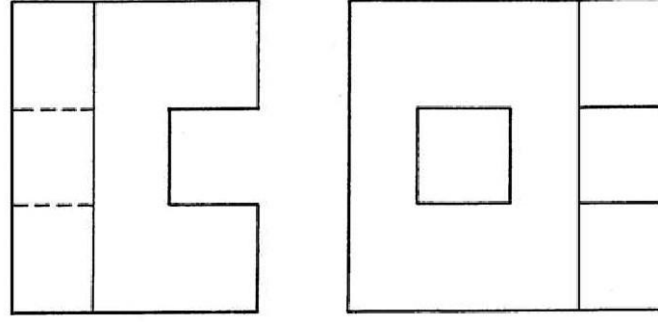
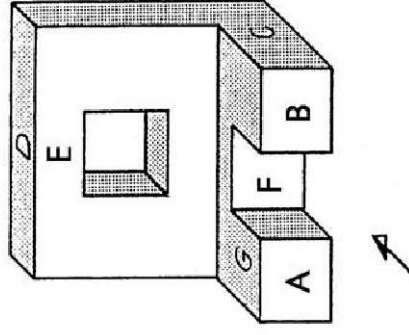
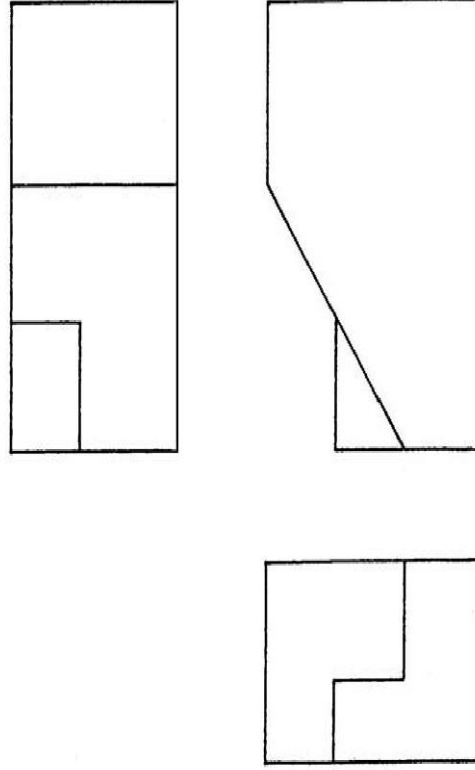
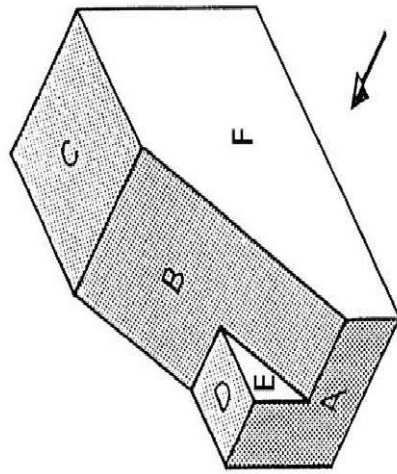

DRG. ORTHOGRAPHIC PROJECTION

EXERCISE 3

EXERCISES. From drawings 1 to 18 opposite select the view which is requested in the table below. Place the number of this view in the

appropriate position in the table.

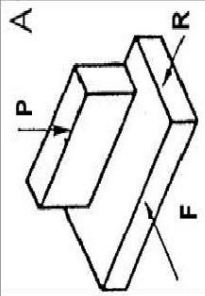
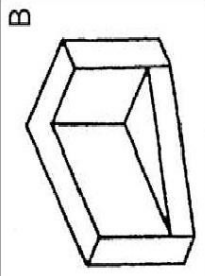
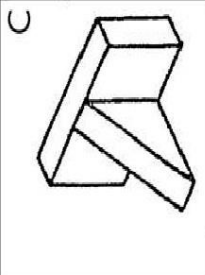
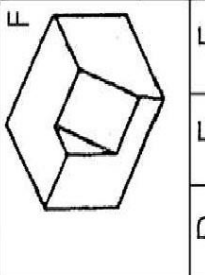
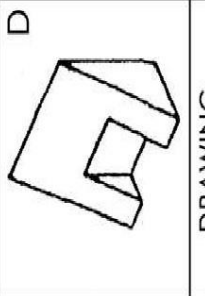
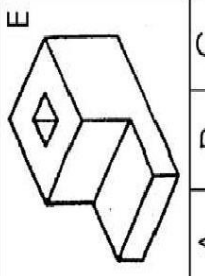
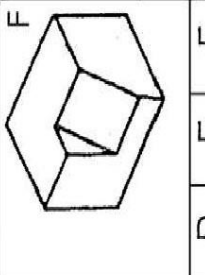
 A	 B	 C							
			 F						
 D	 E	 F	A	B	C	D	E	F	
			FRONT view in direction of F						
			PLAN view in direction of P						
SIDE view in direction of R									

1	2	3
4	5	6
7	8	9
10	11	12
13	14	15
16	17	18

DRG.

ORTHOGRAPHIC PROJECTION

EXERCISE 4

EXERCISES. Study the two types and complete the table by matching the numbered orthogonal drawings with the same isometric view.

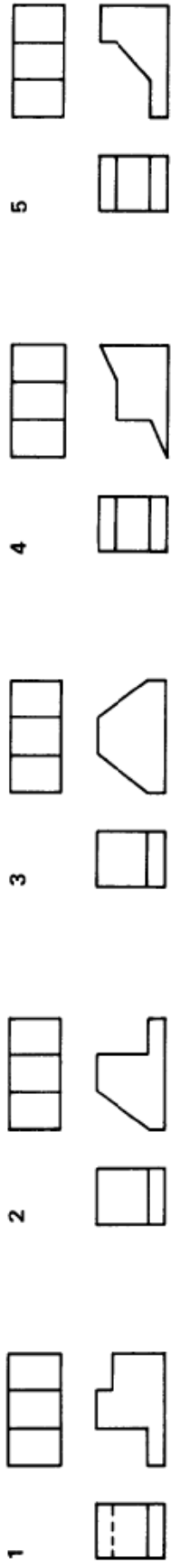

1

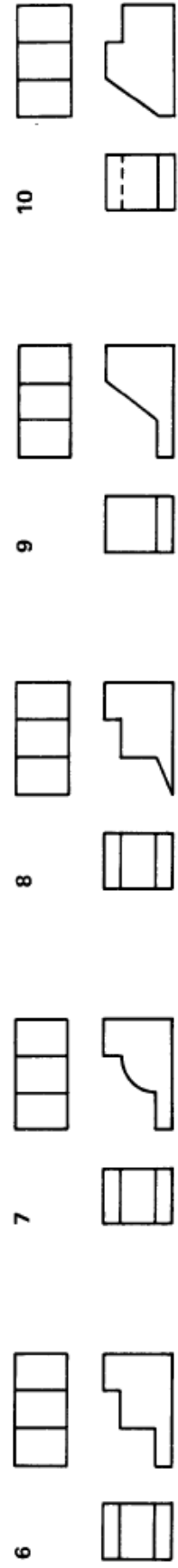
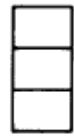
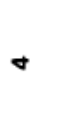
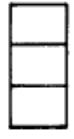

6

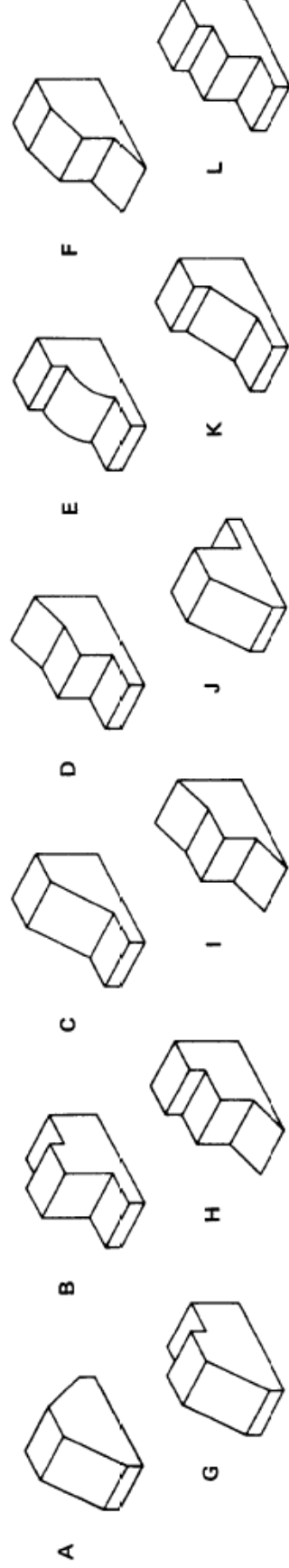
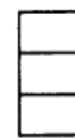
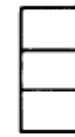
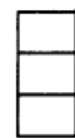

1	2	3	4	5	6	7	8	9	10

DRG. ORTHOGRAPHIC PROJECTION EXERCISE 5

EXERCISES. Study the two types and complete the table by matching the numbered orthogonal drawings with the same oblique view.

G		H		I		J		K		L	
1		2		3		4		5		6	
		7		8		9		10			

A	B	C	D	E	F	G	H	I	J

DRG. _____

ORTHOGRAPHIC PROJECTION

EXERCISE 6

EXERCISES. Study the two types and complete the table by matching the numbered orthogonal drawings with the same isometric view.

G		H		I		J		K		L									
1		2		3		4		5		6		7		8		9		10	

A	B	C	D	E	F	G	H	I	J

DRG. _____ ORTHOGRAPHIC PROJECTION _____ EXERCISE 7

EXERCISES. Study the two types and complete the table by matching the numbered orthogonal drawings with the same isometric view.

1					
6					
A		B		C	
G		H		I	
		D		E	
		F		K	
		L			

1	2	3	4	5	6	7	8	9	10
---	---	---	---	---	---	---	---	---	----

DRG. ORTHOGRAHIC PROJECTION EXERCISE 8

EXERCISES. Study the two types and complete the table by matching the numbered orthogonal drawings with the same isometric view.

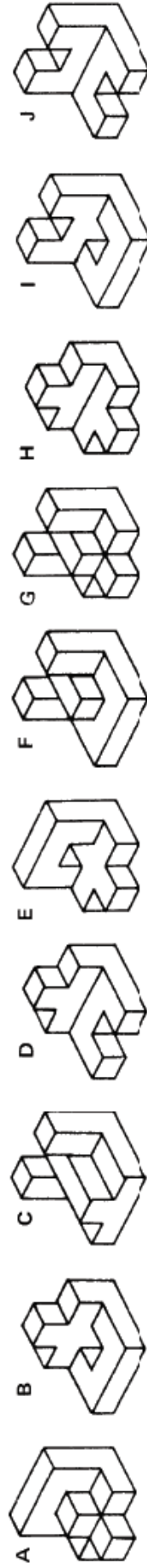
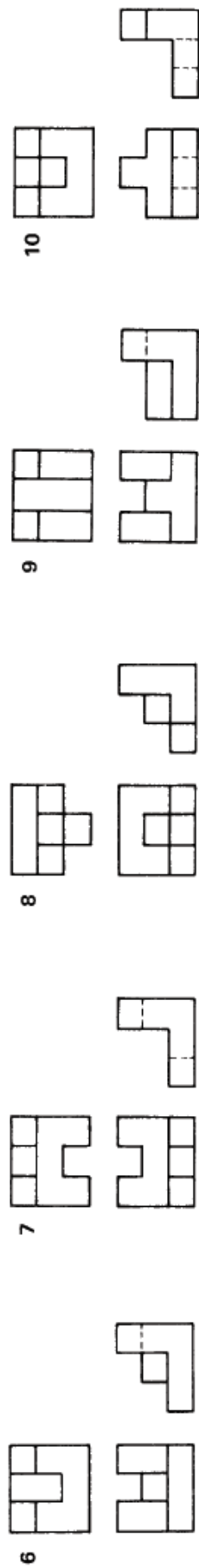
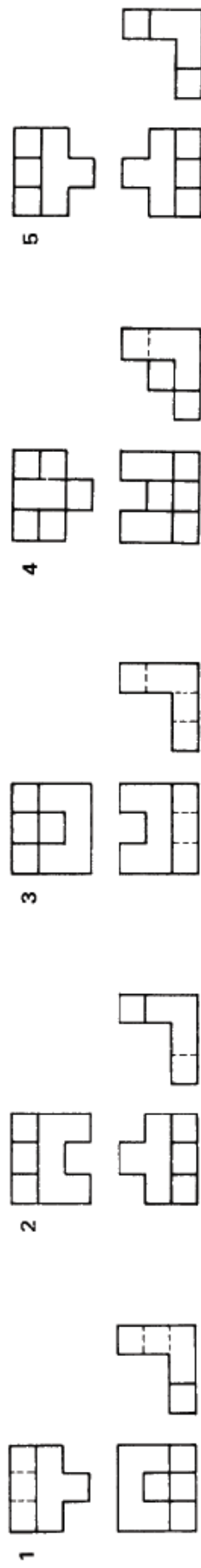

1	2	3	4	5	6	7	8	9	10

DRG.

ORTHOGRAPHIC PROJECTION

EXERCISE 9

EXERCISES. FREEHAND SKETCHING. Sketch an orthographic projection of the component below

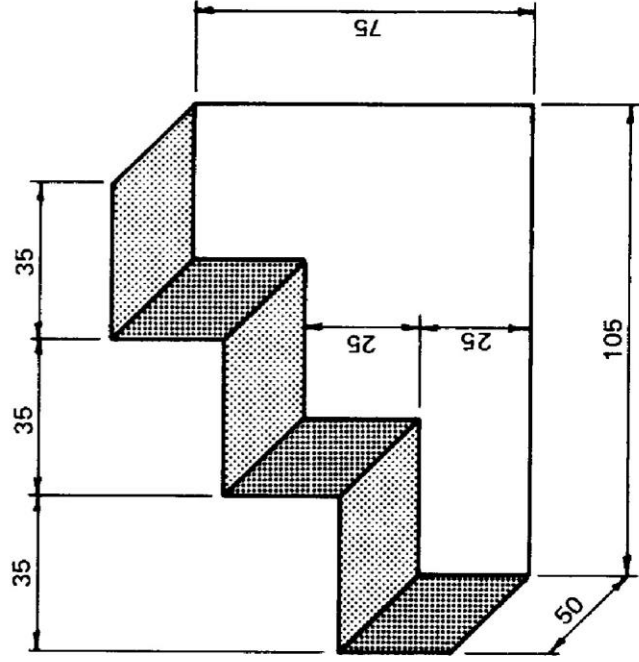

DRG.

ORTHOGRAPHIC PROJECTION

EXERCISE 10

ERCISES. FREEHAND SKETCHING.

Sketch an orthographic projection of the component below

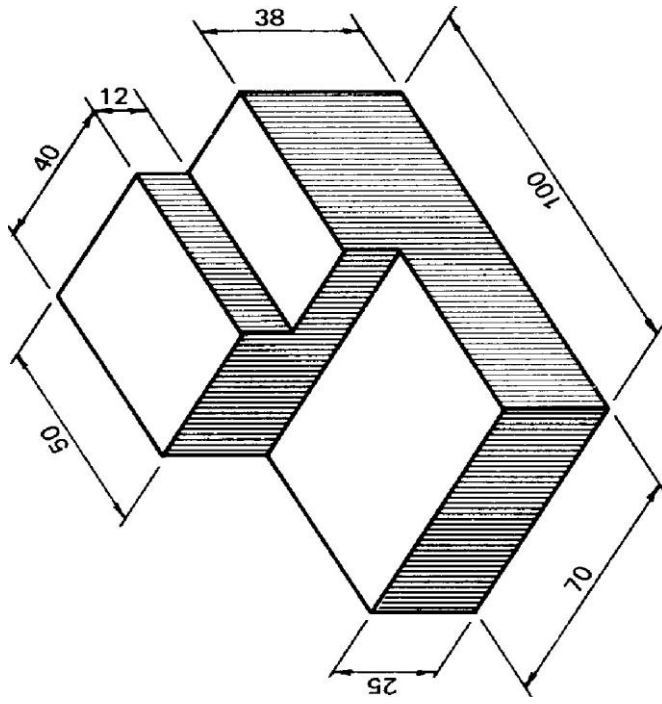

38

ORTHOGRAPHIC PROJECTION

